

**160** LM/W



# SLIM PRO

## LED HIGH MAST LIGHT

LSHM-B600W-LV (XXK)

LSHM-B720W-LV (XXK)

# 600W 720W

For area lighting for applications:

Airports, Golf course | Sport Fields | Stadiums |  
Shopping Centers | Prisons | Expressways |  
Industrial Facilities and Railway Terminals etc.



**SunTech** Led

[www.suntechleds.com](http://www.suntechleds.com)



## 1 SILM PRO SERIES

SILM PRO series LED HIGH MAST LIGHT is built with robust Folding aluminum fin module housing and heavy duty anticorrosive surface treatment for sparking the beauty and improving lighting conditions of applied area. Originated by the demand for large field lighting applications, SILM PRO series flood lights can be extended to 1440W and fixture efficacy reaches to 165LPW, better brilliance, less energy consumption.

## 2 IP66 WATERPROOF & IK10

1. High luminaire efficiency up to 160lm/w
2. Marine grade aluminum housing
3. IP66 and IK10 protection rate
4. 5 years warranty
5. Folding aluminum fin design which are very light weight

M20 Waterproof Breathable Pressure Relief Vent Plug

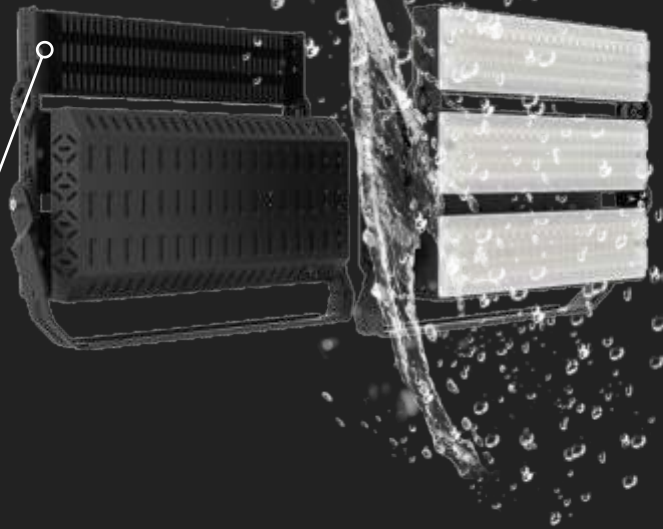

## 3 Folding aluminum fin design

Folding aluminum fin design which are very light weight. Increase the heat dissipation surface area by air cooling to dissipate heat and expand the contact area with air! It speeds up the spread of heat! Thermal effect is good! Compared with traditional die-cast aluminum and profile aluminum, which is heavier and there are certain safety risks. On the contrary, the aluminum fin heat sink are more secure.



The module heat sink adopts the hemming design to prevent the deformation of the heat sink due to crash during the shipment and enhance the flatness and strength of the contact surface of the module heat sink.



### Folding Aluminum Fin

High pure thermal conductive module Folding aluminum fin heat sink is made with high pressure Folding technology

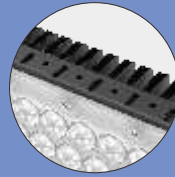

The module heat sink adopts the hemming design to prevent the deformation of the heat sink due to crash during the shipment and enhance the flatness and strength of the contact surface of the module heat sink.

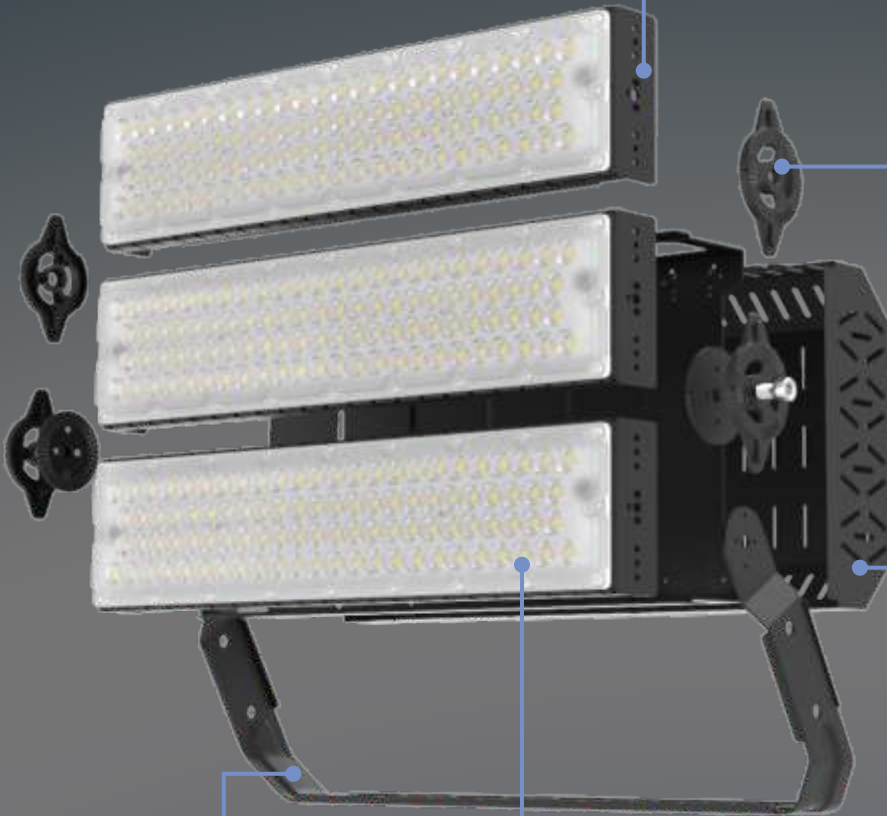

### Module Connecting Piece

The slim pro series high mast lights reduce the side bar fixing, and adopt the die-cast connecting pieces which has greatly reduces the weight of the whole lamp.

### Driver Shell

Use a driver shell to avoid the driver to be directly exposed to the air, increase the distance between the driver and the lamp body, and the driver has better heat dissipation.

### PC Lens

The optical lens is made of PC, and the transmittance reaches 92%, reducing light loss, maximize the lumens on where it should be lit up and evenness, minimize lighting pollution to nature and human life.

### Swivel Bracket

The fixing bracket is made of high-strength material and is bent at an angle of 45° to make the lamp body better installed.



# DESIGN FOR HIGH VERSATILITY



50,000H



-30~45°C



IK10



IP66



High Efficiency



Energy Saving



Long-life Span



Low Light Attenuation

## Folding Aluminum Fin

High pure thermal conductive module Folding Aluminum Fin Heat sink is made with high pressure Folding technology.

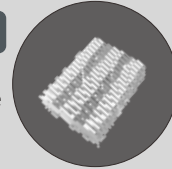

## Professional optics

The optical lens is made of PC, and the transmittance reaches 92%, reducing light loss, maximize the lumens on where it should be lit up and evenness, minimize lighting pollution to nature and human life.



## Module Rotatable

Module Rotatable  $\pm 25^\circ$ , Separate module can be mounted on the same robust bracket to offer the utmost flexibility.

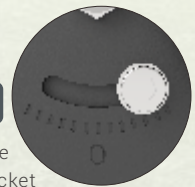

## Installation Versatility

The fixing bracket is made of high-strength material and is bent at an angle of  $45^\circ$  to make the lamp body better installed.

# Adjustable Module

Flood / High Mast / Stadium Lights

Maximize the lumens on where it should be lit up and evenness  
Minimize lighting pollution to nature and human life.

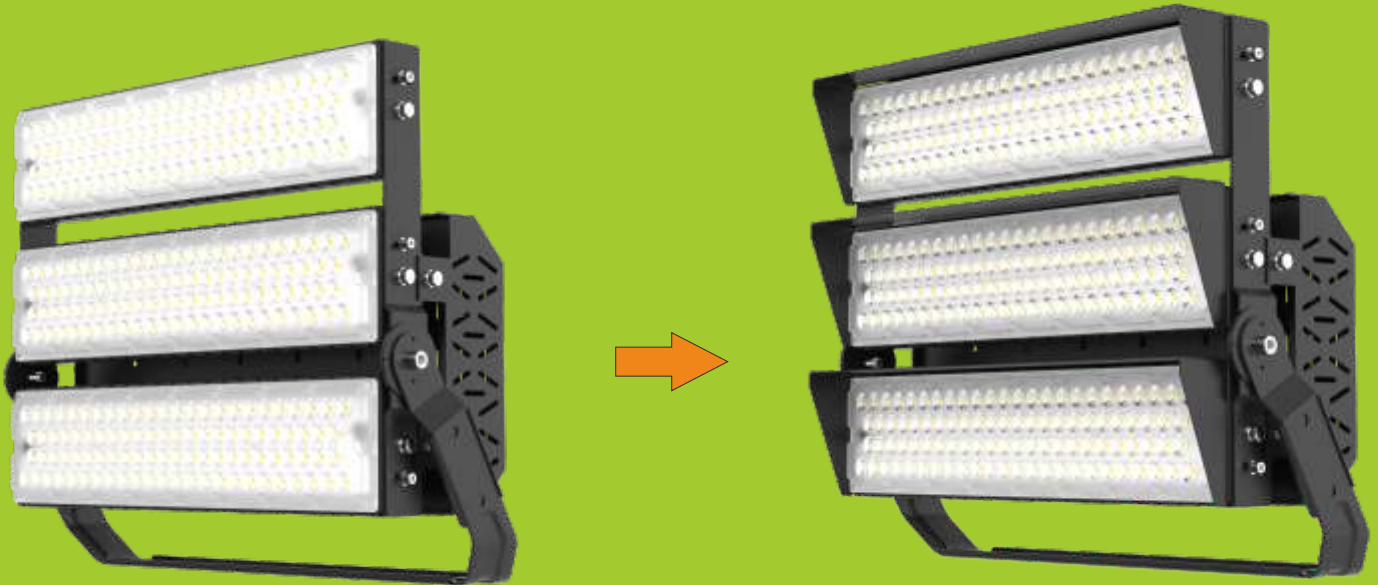

Anti-glared Visor



Model None Rotatable

Module Rotatable  $\pm 25^\circ$



# SLIM PRO SERIES

## Module Rotatable LED Floodlights



### Dimension

Unit:mm

#### Model None Rotatable

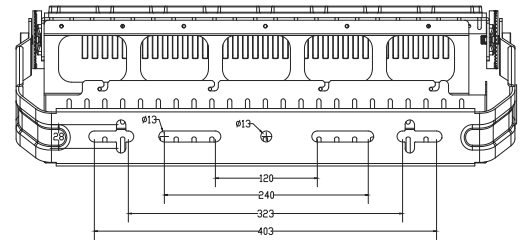
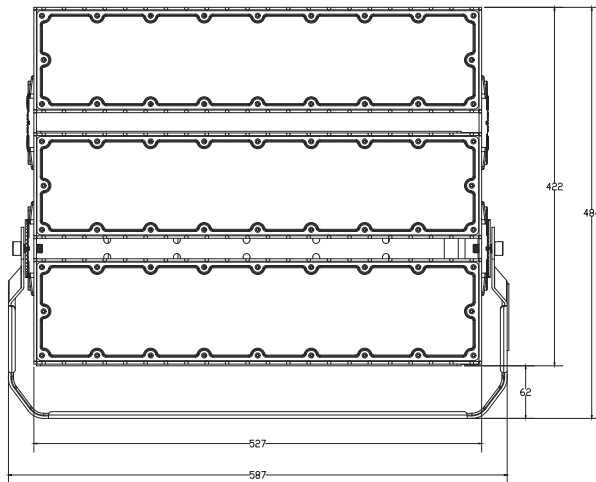
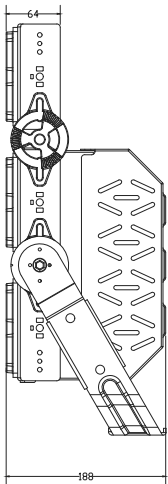

#### Module Rotatable

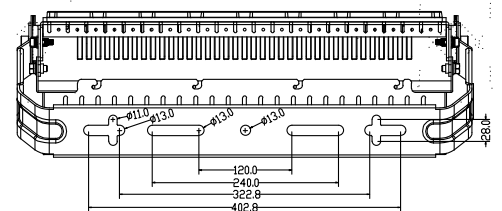
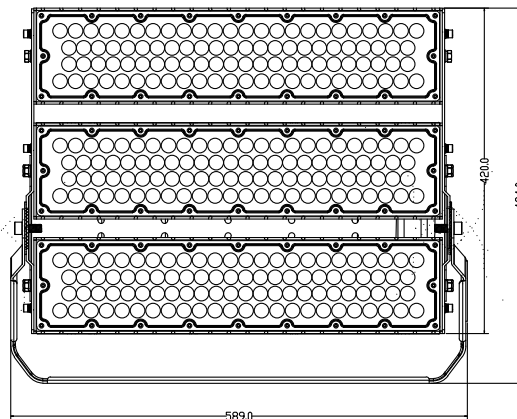
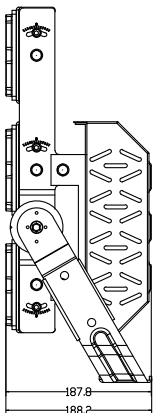

Fixture fixed hole size diagram



# SLIM PRO

## LED HIGH MAST LIGHTS

- Light Source: Luminleds 5050
- Input Volt: 100-277VAC
- IP Rating IK Rating : IP66 & IK10
- Beam Angle: 10° 20° 40° 60° 90° 140x100° 135x60°(P50)
- Color Temp: 3000K 4000K 5000K 5700K 6000K
- Size: 587\*484\*188mm
- Weight: 11.4Kg
- 5 years warranty



Black Grey



**FLAME RETARDED**



**SALT SPRAY TEST**



100-277V



347-480V



Dimmable



50,000H



Adjust  
270°



-30~45°C



IK10



IP66



Folding Aluminum Fin

### Specifications

Part Number	LSHM-B600W-LV(XXK)	LSHM-B720W-LV(XXK)
Watt	600W	720W
Efficiency	160LM/W±3%	160LM/W±3%
Lumen	96,000Lm	115,200Lm
Driver	Meanwell Driver 3pcs XLG-240-H-A	Meanwell Driver 3pcs XLG-240-H-A

### Beam Angle

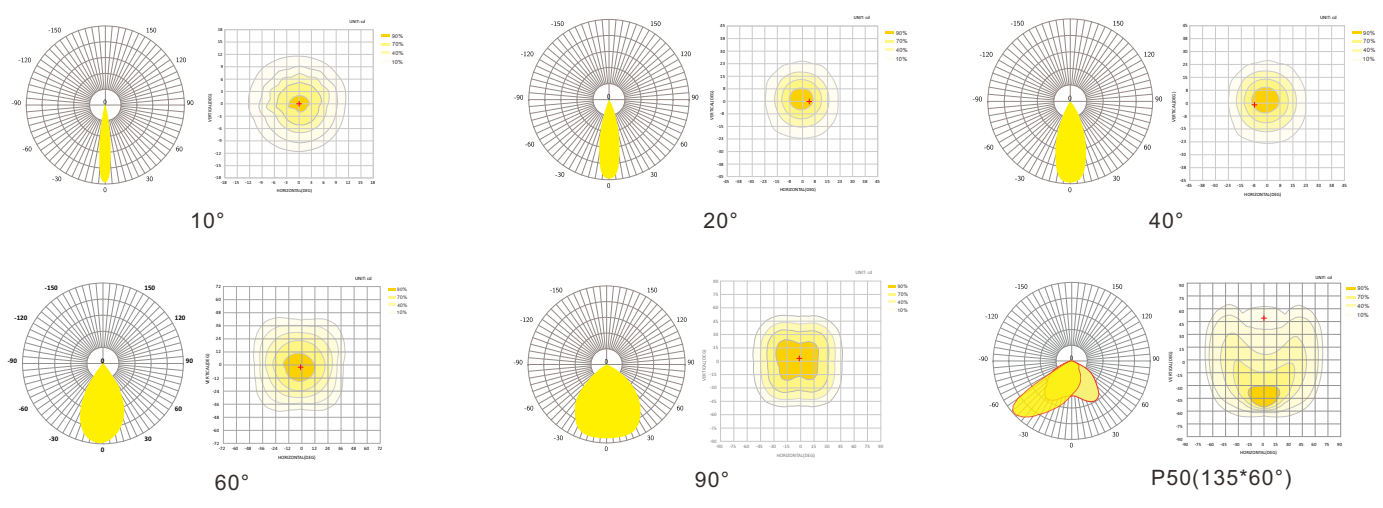

# SLIM PRO SERIES

## Module Rotatable LED Floodlights



### Features

1. High luminaire efficiency up to 160lm/w
2. Marine grade aluminum housing
3. IP66 and IK10 protection rate
4. 5 years warranty
5. flicker Free drivers
6. Folding aluminum fin design which are very light weight
7. 3000K is 10-15% lumen less compared to 5000K
8. remote driver box available
9. All lamps come with driver box at the back
10. ETL DLC ENEC TUV CE CB SAA RoHS REACH LM79 LM80 TM21 IK10 Salt Spray test approved



### Accessories

Unit:mm



Slip fitter(60mm)

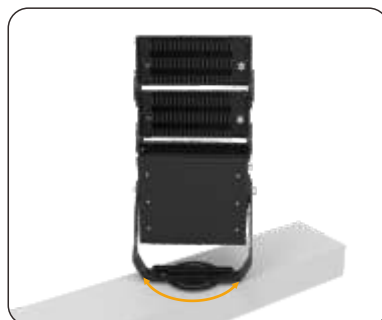

Round installation plate



Anti-glared Visor

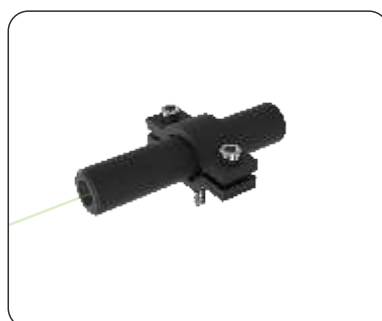

laser pointer



Remote driver box



Remote driver box



## Application



For area lighting for interior and exterior applications:  
airport, golf course, factories, plants, warehouse, exhibition halls, gym, seaport, highway, high mast lighting and etc.

## Installation

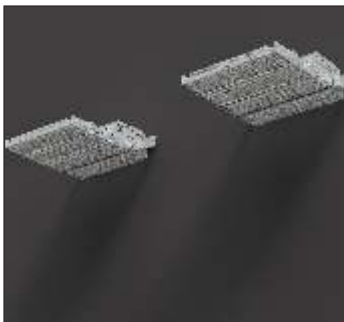

## Package details

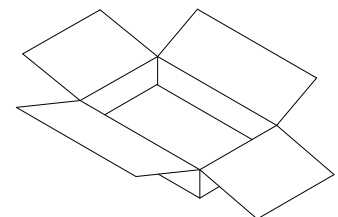
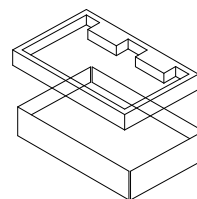
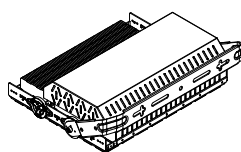
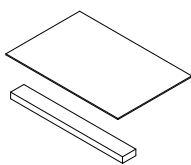

Wattage	Size of Box	Weight	Box Quantity
600W/720W	61.2x55.6x23.7cm	13.6Kg	1PC